

SLANT FACE PLENUM DIFFUSER

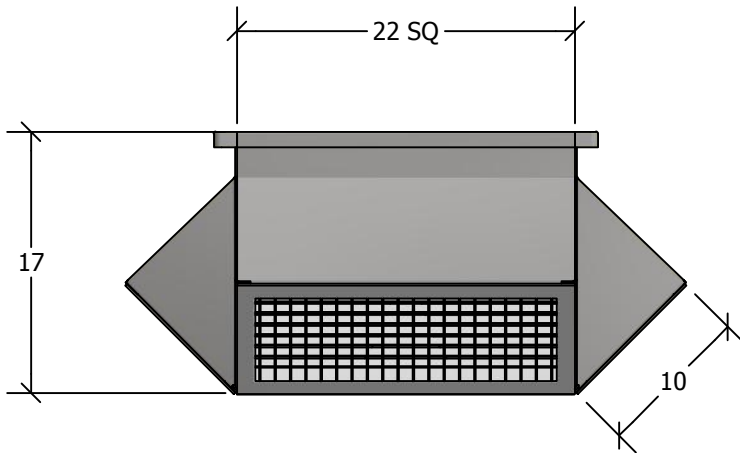

STANDARD FEATURES

1. G-90 Galvanized Steel Construction.
2. Turning Vanes in Each Quadrant.
3. 1" 1-1/2 lb. Duct Liner.
4. Vertical and Horizontal Adjustable Deflection Grilles.
5. Fully Assembled
6. TDC Duct Connections Provided.
7. 3/8" Threaded Inserts for Mounting Available.
8. Engineered Curb and Duct Packages Available

NOM CFM 3,000	MODEL NO SFPD 2008-7.5	WEIGHT 43 LBS
0° DEFLECTION		
THROW 49'	P.D. .11	NC 26
22 1/2° DEFLECTION		
THROW 39'	P.D. .12	NC 27
45° DEFLECTION		
THROW 22'	P.D. .17	NC 33

QTY TAG

JOB NAME

CURBS PLUS, INC.
www.curbs-plus.com