

SLANT FACE PLENUM DIFFUSER

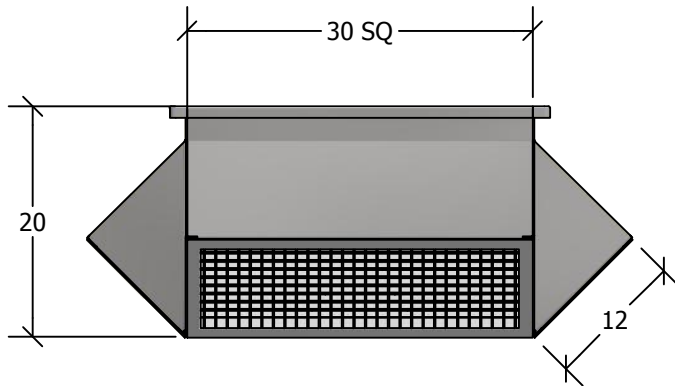

STANDARD FEATURES

1. G-90 Galvanized Steel Construction.
2. Turning Vanes in Each Quadrant.
3. 1" 1-1/2 lb. Duct Liner.
4. Vertical and Horizontal Adjustable Deflection Grilles.
5. Fully Assembled
6. TDC Duct Connections Provided.
7. 3/8" Threaded Inserts for Mounting Available.
8. Engineered Curb and Duct Packages Available.

NOM CFM 6,000	MODEL NO SFPD 2810-15	WEIGHT 71 LBS
0° DEFLECTION		
THROW 72'	P.D. .15	NC 35
22 1/2° DEFLECTION		
THROW 56'	P.D. .16	NC 36
45° DEFLECTION		
THROW 33'	P.D. .23	NC 42

QTY TAG

JOB NAME

CURBS PLUS, INC.
www.curbs-plus.com