

SLANT FACE PLENUM DIFFUSER

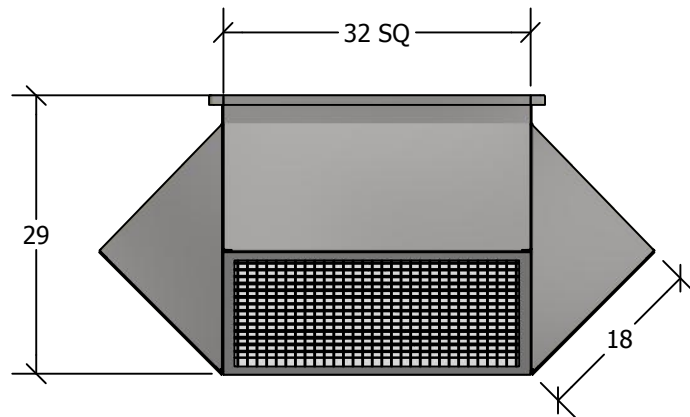

STANDARD FEATURES

1. G-90 Galvanized Steel Construction.
2. Turning Vanes in Each Quadrant.
3. 1" 1-1/2 lb. Duct Liner.
4. Vertical and Horizontal Adjustable Deflection Grilles.
5. Fully Assembled
6. TDC Duct Connections Provided.
7. Engineered Curb and Duct Packages Available.

NOM CFM 8,000	MODEL NO SFPD 3016-20	WEIGHT 110 LBS
0° DEFLECTION		
THROW 79'	P.D. .12	NC 29
22 1/2° DEFLECTION		
THROW 61'	P.D. .13	NC 30
45° DEFLECTION		
THROW 36'	P.D. .18	NC 36

QTY TAG

JOB NAME

CURBS PLUS, INC.
www.curbs-plus.com